

Features

- Ceramic Disc Cartridge
- Lever Style Handles
- 1/2" Male NPSM Connections
- Max Flow Rate: 1.5 GPM @ 60 PSI
- Matching Pop-Up Drain Included

Codes/Standards

Specified model meets or exceeds:

- ASME A112.18.1/CSA B125.1
- NSF 61 Section 9
- IAPMO/UPC listed
- AB1953 low lead
- WaterSense
- ADA compliance to ANSI A117.1

Installation Notes

- Maximum counter thickness: 1-1/4"
- Install in 3-hole sinks with outside holes 4" apart

Warranty

Limited Lifetime Warranty. See complete warranty statement for details.

GIAGNI

Mitchell Centerset Lavatory Faucet

Model LL404

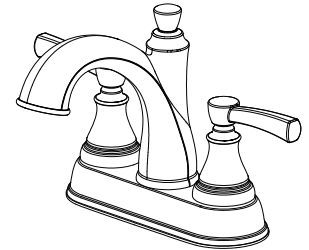

MODEL	FINISH
LL404-BN	Brushed Nickel PVD

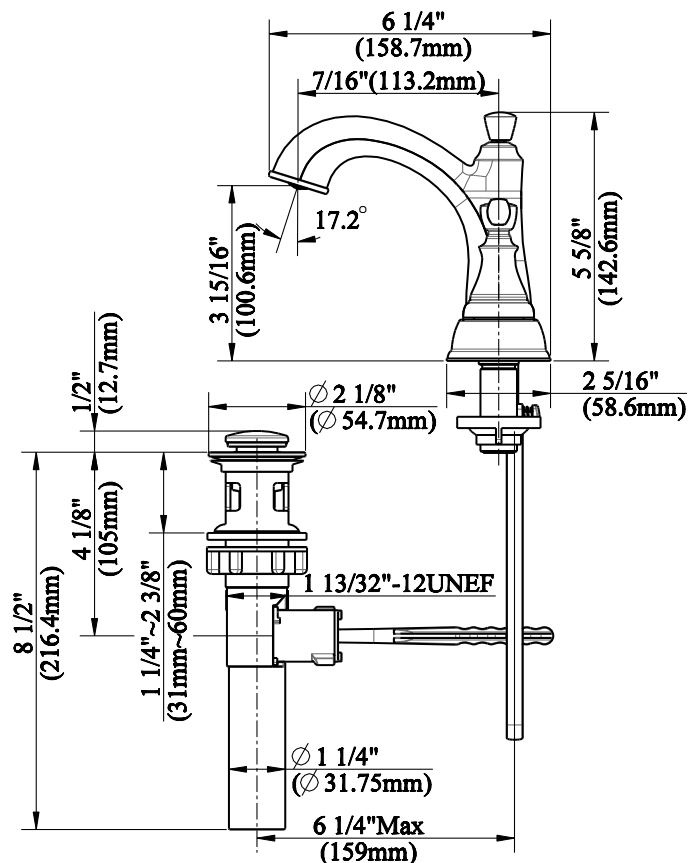
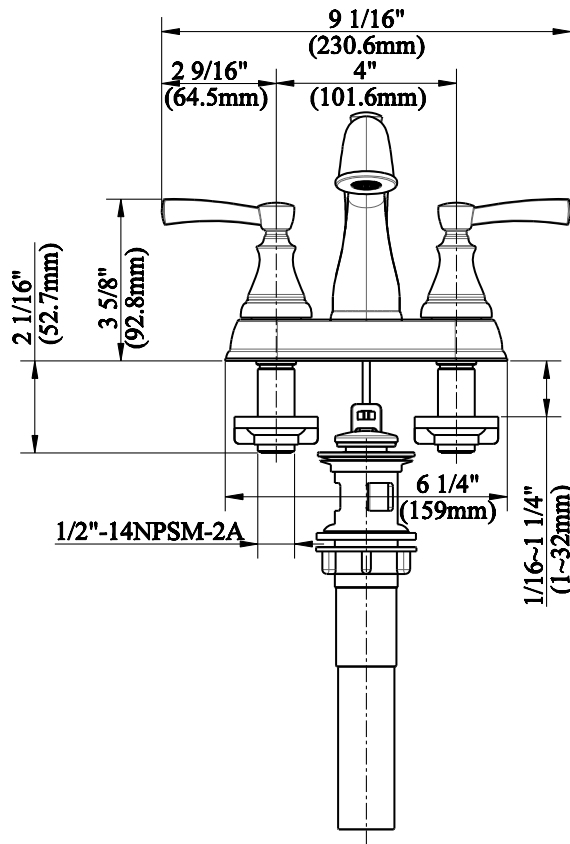

Giagni reserves the right to make specification and pricing changes without notice or obligation, and to change or discontinue models and finishes.

GIAGNI A QMI, Inc Brand

548 South Columbus Avenue • Mount Vernon, New York 10550 • 1-888-560-5222 • www.giagni.com

LL404 (09/14) All rights reserved. © Giagni 2015