

Stainless Steel Undermount Kitchen Sink

30" x 19" x 10" Deep

GIAGNI

Model GSS3019U1

Unpack and inspect your sink upon delivery to avoid costly contractor delays

Product Features

- High quality 16 gauge 304 stainless steel alloy
- Sound deadening rubber pads and undercoating
- 10mm radius corners for easy cleaning
- Includes stainless steel wire grid
- Includes all-metal basket strainer drain

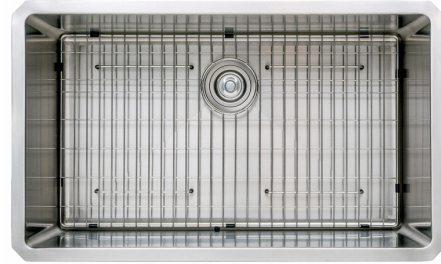

This sink is intended only for under-counter installations of solid-surface composite or natural stone countertops. It is highly recommended that this product be installed by professionals.

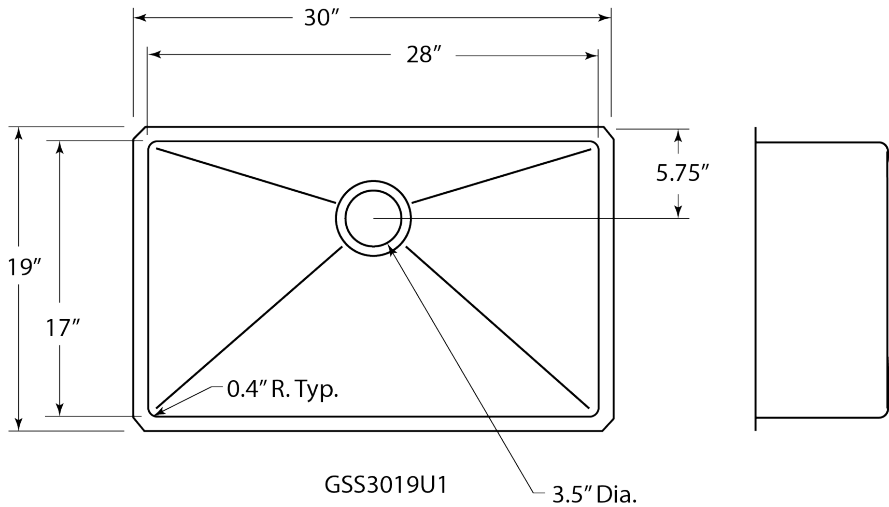

Rough-In Dimensions

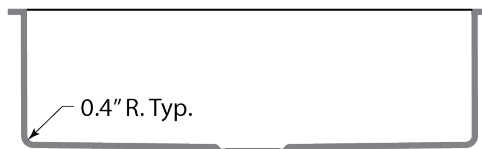

Installation



This sink is intended only for under-counter installations of solid-surface composite or natural stone countertops. It is highly recommended that this product be installed by professionals.

Observe all applicable plumbing codes in your municipality

Installer:

Template supplied with product is for reference only. Be sure to double check with the actual sink before cutting opening. Be sure to properly allow clearance for the mounting hardware

Mounting anchors and brackets have been supplied with this product, but it is always best to use your own preferred methods of sink securement and attachment, given the different applications and materials that may be involved.

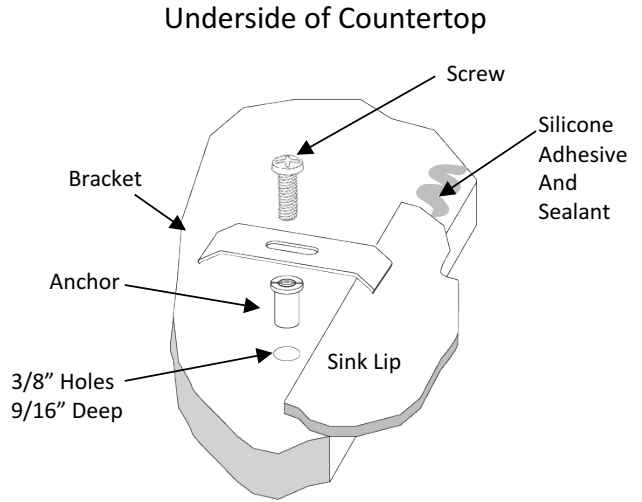

Care

Stainless steel sinks are durable, but they do benefit from proper care. If you want your sink to always look it's best we recommend the following :

- Clean using a non-abrasive, mild detergent.
- Use only a sponge or soft cloth for cleaning.
- Avoid using steel wool for cleaning anything within the sink.
- Remove any cast iron or steel pans promptly after cleaning.
- Keep the sink clean, dry and empty when not in use.
- Don't leave sponges and other wet items in the sink.
- If you want to avoid water spots, wipe your sink dry after each use.

Warranty

Limited lifetime warranty on residential applications or limited one year for commercial applications extended to the original purchaser or owner covering defects in material and workmanship. Excluded is damage done to the surface by disregarding the care recommendations provided in the installation instructions, or improper installation. This warranty does not cover products not installed by a qualified professional installer. Warranty covers replacement of the defective product only and does not cover installation or other consequential costs or damages.

GIAGNI

Giagni, Inc. 548 S. Columbus Ave Mount Vernon, NY 10550

Toll-free: 1-888-560-5222

email: info@giagni.com

Website: www.giagni.com